



**MFPT-100-300M+ 脉冲光纤激光器**

**使用手册**

## 版权说明

“ ”

---

## 引 语

MFPT

MFPT



.....	1
<b>第一章 特性说明</b> .....	<b>4</b>
<b>第二章 安全信息</b> .....	<b>5</b>
1- .....	5
2- .....	6
3- .....	6
4- .....	9
<b>第三章 产品描述</b> .....	<b>10</b>
1- .....	10
2- .....	10
3- .....	11
<b>第四章 详细规格</b> .....	<b>12</b>
1- .....	12
2- .....	13
3- .....	13
<b>第五章 使用指南</b> .....	<b>15</b>
1-DB25 .....	15
2- .....	20
3- .....	22

4-	.....	22
5-	.....	25
6-	.....	26
7-	.....	28
8-	.....	31
<b>第六章 常见故障处理</b>	.....	<b>40</b>
1-	.....	40
2-	.....	40
<b>第七章 服务与维修</b>	.....	<b>41</b>
1-	.....	41
2-	.....	41
<b>第八章 保修声明</b>	.....	<b>42</b>
1-	.....	42
2-	.....	42

# 第一章 特性说明

MFPT-100-300M+



1060-1070 nm

MFPT-100-300M+

Class 4

## 第二章 安全信息

1 -

1060nm

Class

100W

2-

1

2

LaserVision USA   Kentek Corporation   Rochwell Laser Industries

3-

1



2

3

1

2

3

4

5

6

7

8 焦距 510mm 及以上场镜，除漆效果暂无法保证。

9 K9

"

"

4

AC

220VAC

5

1

2

5cm

4

3

6

1



2

3

4

5

6

## 4-

Laser Institute of America(LIA)

13501 Ingenuity Drive, Suite 128

Orlando,Florida 32826

Phone:407 380 1553,Fax: 407 380 5588

Toll Free:1 800 34 LASER

American National Standards Institute

ANSI Z136.1, American National Standard for the Safe Use of Lasers

(Available through LIA)

International Electro-technical Commission

IEC 60825-1, Edition 1.2

Center for Devices and Radiological Health

21 CFR 1040.10 - Performance Standards for Light-Emitting Products

US Department of Labor - OSHA

Publication 8-1.7 - Guidelines for Laser Safety and Hazard Assessment.

Laser Safety Equipment

Laurin Publishing

Laser safety equipment and Buyer' s Guides

## 第三章 产品描述

1-

MFPT-M+

MOPA

1064 nm

10 kW

25 Pin

1

2

3

4 25

RS232

1

2

2-

MFPT-100M+	100W
MFPT-120M+	120W
MFPT-150M+	150W
MFPT-200M+	200W

MFPT-250M+	250W
MFPT-300M+	300W

品牌名称	类别种类	产品系列	系列种类	系列代码
M:MAX 激光中国 芯	F:Fiber laser 光纤激光器	P: Pulsed 脉冲	空缺：默认脉宽不可调 (Q-Switch 声光调Q)	MFP
			T: Tunable 脉宽可调	MFPT
			P: Picosecond 皮秒	MFPP
			F: Femtosecond 飞秒	MFPF
			N: Nano 小型化	MFPN

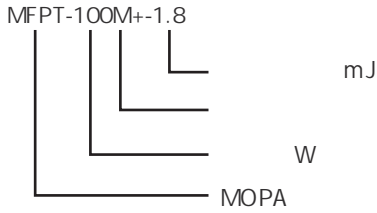

## 第四章 详细规格

1-

	MFPT- 100M+-1.8	MFPT- 120M+-1.8	MFPT- 150M+-1.8	MFPT- 200M+-1.8	MFPT- 250M+-1.8	MFPT- 300M+-1.8
	&					
(W)	100	120	150	200	250	300
(mJ)	1.8					
(ns)	10~500					
(kHz)	1~4000					
(kHz)	55~4000	65~4000	80~4000	110~4000	150~4000	165~4000
M2			<1.6,	1.3		
(%)	<5					
(VDC)	220					
(W)	~550	~600	~700	~900	~1100	~1300
(nm)	1066± 3					
3dB (nm)	<15					
(%)	10~100					
(mm)	5~7*				8± 1*	
	90%					

(m)	5m*
-----	-----

\*

2-

1		0-40	
2		-10-60	
3		10-95	%
4			
5	10%~90%	10	us
6	90%~10%	10	us
7		490.4*422*131.3	mm
8		25	kg

3-

100~300M+

mm

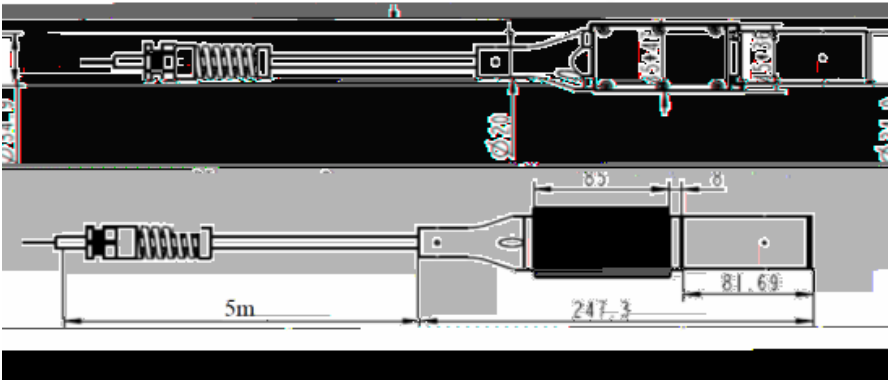

100~300M+

mm

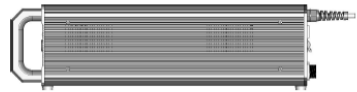
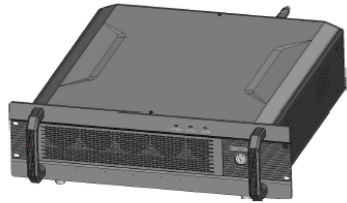
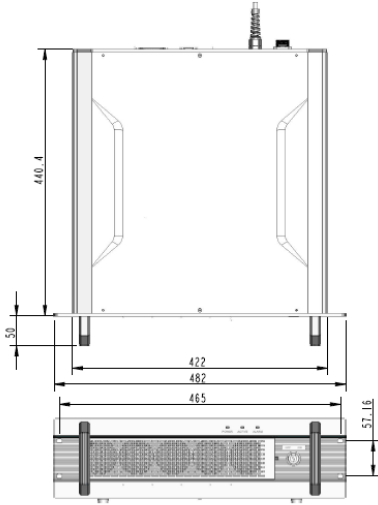
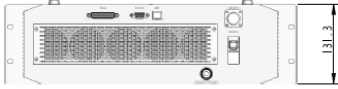

## 第五章 使用指南

	1

### 1 -DB25

1

Pin TTL

TTL

Pin #	
1-8 DO-D7	1. 16 0-FF 10 0-255 LSB(D0) Pin1, MSB(D7) Pin8 - 00h(0): - FFh(255): - 00h.
	2. DB25.22  D1 D2

9	
14 15	
11 12 16 21	
17	+5± 0.25V DC
18	MO
	: MO
	: MO
19	booster /
	: booster
	: booster
20	( )
22	1. ( ) /
	2. ,
23	: :
24 25	

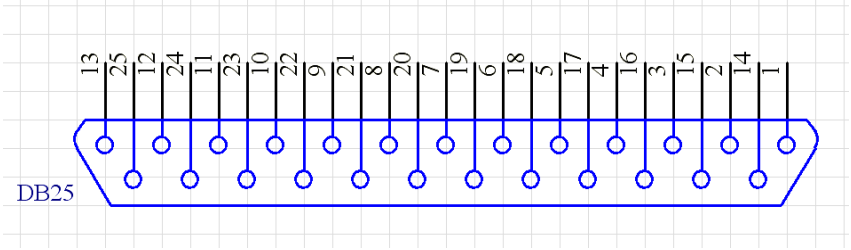

2

**DB-25**

1 DB25

2 Pin1~8 8bit Pin1 LSB Pin8 MSB Pin  
0~255 0~100%

	1	2	3	4
Pin1	0	0	0	0
Pin2	0	0	0	0
Pin3	0	0	0	0
Pin4	0	0	0	0
Pin5	0	0	0	1
Pin6	0	0	1	1
Pin7	0	1	1	1
Pin8	1	1	1	1
	50%	75%	87.5%	93.75%

3 Pin 9 Pin 1~8 Pin 9

Pin 9 1μs Pin 1~8

Pin 1~9 2μs

10 kHz

100µs

4 Pin 11 Pin 12 Pin 16 Pin 21 Pin 11

Pin 12

Pin12	Pin11	Pin16	Pin21	
		L	L	
		H	L	PD
		L	H	
		X	X	

Pin 18 Pin 19

Pin 11 Pin 12 Pin 16 Pin 21

5 Pin 18 EE

5ms

Pin 9 EM

PCB Pin 18

Pin 18 Pin 18

PCB Pin 19 Pin 19

6 Pin 19 Pin 19

Pin 19



2-

1

1  
 2 DB25 5.2.2  
 DB25  
 3

Pin 18 19 22	
Pin 23	
Pin 20	

4  
 5 220VAC 10  
 6 Pin 1-8 Pin 9  
 7 Pin 18 EE  
 8 5 ms  
 9 Pin 19 Pin 19  
 ON/OFF  
 10 ON/OFF EM OFF 500 ms

EE

11 EE EM Pin 18 Pin 19  
 12

2

1 Pin 20

Pin 20

2	Pin 20				
Pin 20					
3			Pin 1~8		Pin 9
4	Pin 18	Pin 19			
5	EE ON	EM OFF			
6	EE ON	EM ON		Pin 1~8	
7			Pin 22	EE	EM
		EE EM	ON		OFF
	Pin 18	Pin 19		Pin 22	
	EE	EM			
8					
Pin 11	2 P	2 #	Pin 16	Pin 21	
	2 P				
9					Pin 16
Pin 21					

3 -

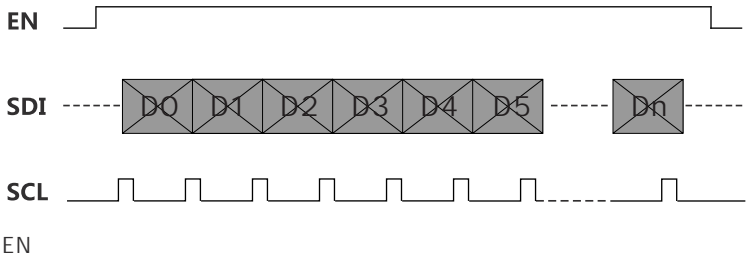

2

4 BYTE 32 bit

[HEAD] -> [PULSEWIDTH]

2 BYTE 2 BYTE

HEAD = 0x A501

PULSEWIDTH =

10ns, 0x A501000A 32bit

4 -

1

1

5 ms

10 s

2

EE

1 μs

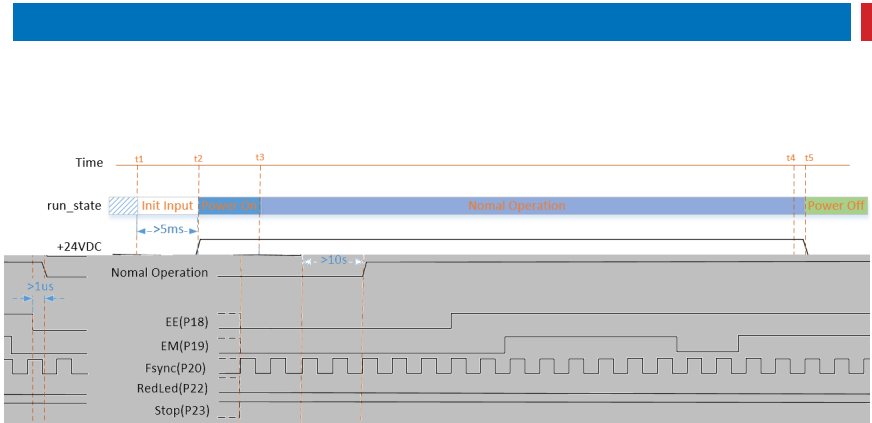

2

1

EE

5 ms

EM

EM

200 ns

2

EM

1  $\mu$ s

EE

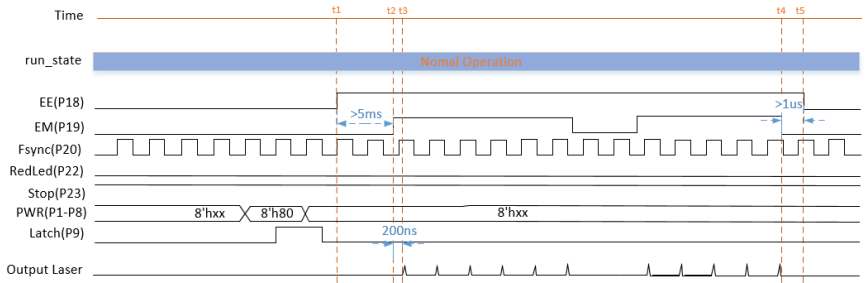

3



4  $\mu$ s

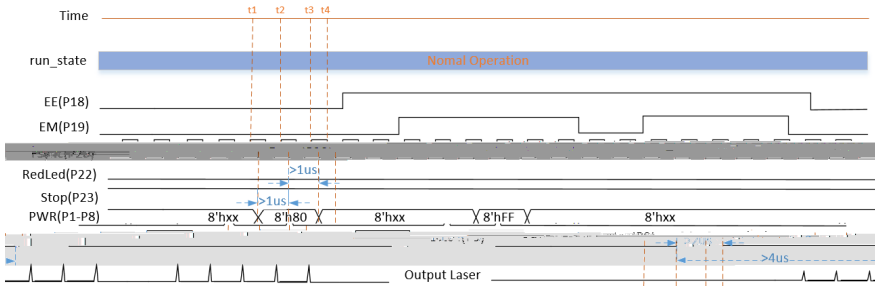

4

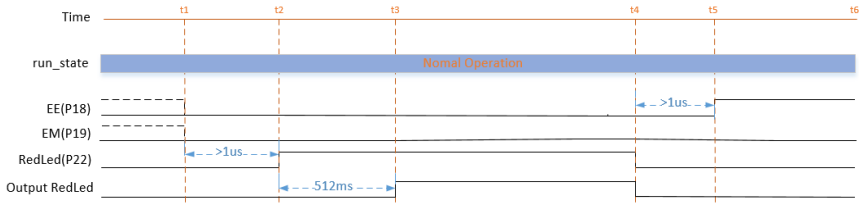

## 5 STOP

1 Stop

Stop

Stop

100 ms

2

Stop

1 s

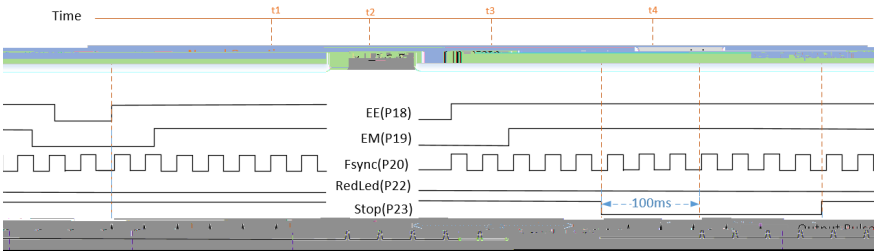

5-

1

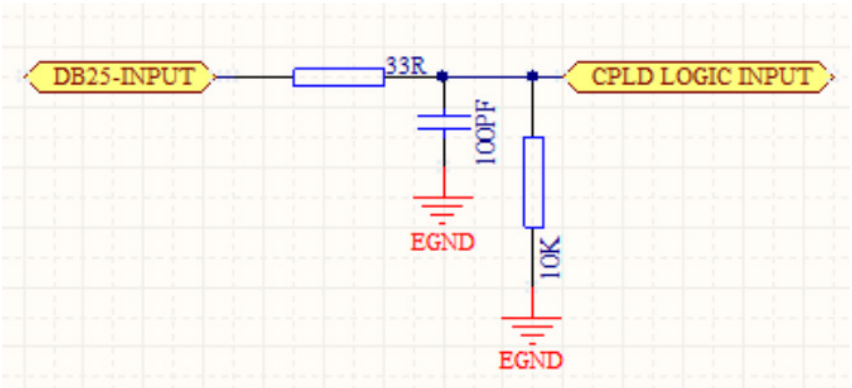

5± 2V

2

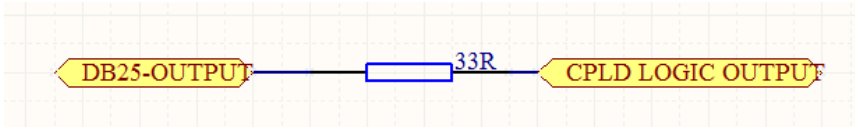

5V

10 mA

6 -

MFPT

MFPT

KHZ

ns	/kHz						
	MFPT-100M+	MFPT-120M+	MFPT-150M+	MFPT-200M+	MFPT-250M+	MFPT-300M+	/kHz
1	CW	CW	CW	CW	CW	CW	CW
10	1100	1600	2100	2200	3000	4000	4000
15	680	1100	1400	1400	2000	2500	3000
20	500	900	1150	1050	1600	1700	3000
30	340	600	750	700	1000	1100	2000
40	270	430	540	550	800	850	2000
50	230	340	450	450	650	730	2000
60	200	280	370	400	530	620	2000
80	170	210	280	350	450	530	1500
100	150	165	215	300	400	420	1500
120	120	145	190	260	310	350	1000
150	98	120	150	220	260	320	1000
180	85	100	130	185	220	280	1000
200	80	95	120	170	210	250	1000
220	75	88	115	155	190	240	900
250	70	82	106	145	185	220	800
300	63	75	96	130	170	200	700
350	58	68	90	120	155	185	600
400	55	65	85	115	150	175	500
450	55	65	82	110	150	165	500
500	55	65	80	110	150	165	500

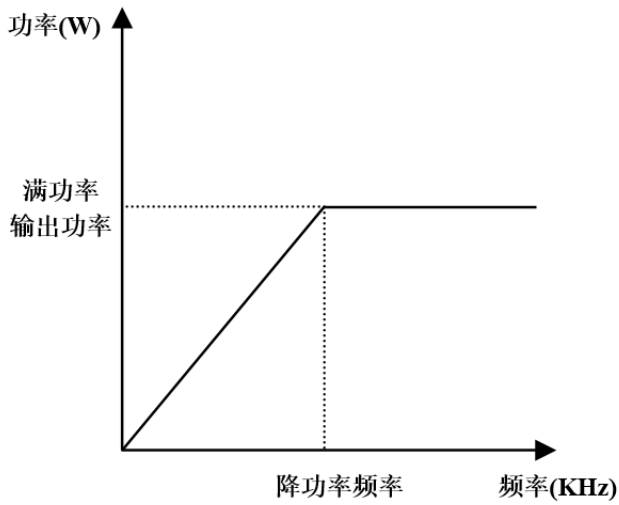

- 1
- 2

MFPT-300M+

500 ns

165 kHz

165 kHz

300 W

7 -

1

1 RS232

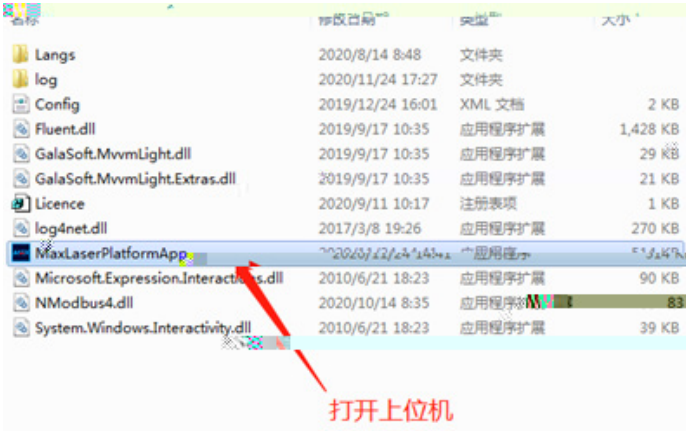

2 RS232 COM  
IP IP IP

192.168.10.xxx



3  
3.1  
3.2

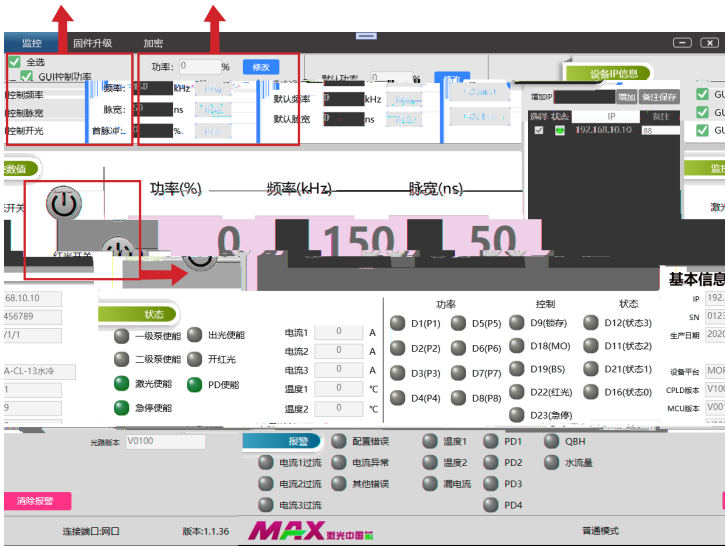

3.3 1



2

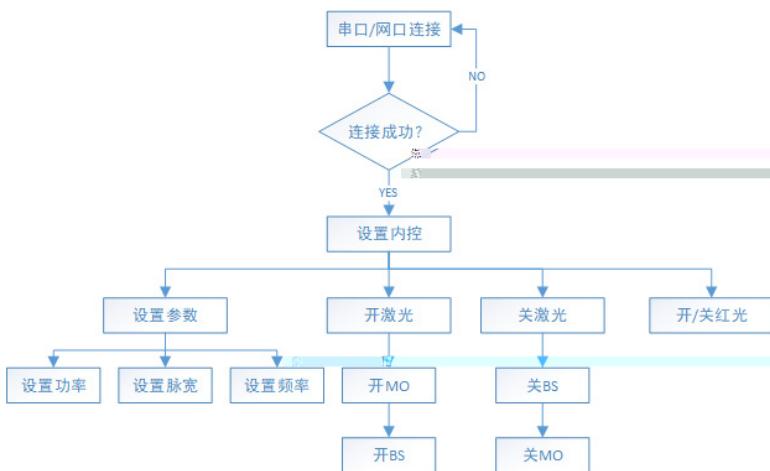

- 1 MO, BS BS
- 2 MO
- 3 RS232/

## 8-

1

230400

8

1

2

IP 192.168.10.10 5000

3

Modbus RTU

byte	1	1	2	N	2

1. 0x7F

2.

0x03

0x06

0x10

1 0x03

Field Name	Example(HEX)	Description
Slave Address	0x7F	
Function	0x03	
Register Address H	0x80	
Register Address L	0x00	
Register Count H	0x00	
Register Count L	0x02	
CRCH		CRC
CRCL		CRC

Field Name	Example(HEX)	Description
Slave Address	0x7F	
Function	0x03	
Byte count	0x04	
Data1 H	0x01	1
Data1 L	0x2B	1
Data2 H	0x01	2
Data2 L	0x11	2
CRCH		CRC
CRCL		CRC

2

0x03

Field Name	Example(HEX)	Description
Slave Address	0x7F	
Function	0x03	
Register Address H	0x80	
Register Address L	0x00	
Register Count H	0x00	
Register Count L	0x01	
CRCH		CRC
CRCL		CRC

Field Name	Example(HEX)	Description
Slave Address	0x7F	
Function	0x03	
Byte count	0x02	
Data1 H	0x01	
Data1 L	0x2B	
CRCH		CRC
CRCL		CRC
CRCL		CRC

3

0x06

Field Name	Example(HEX)	Description
Slave Address	0x7F	
Function	0x06	
Register Address H	0x80	
Register Address L	0x00	
Present Data1 H	0x00	
Present Data1 L	0x02	
CRCH		CRC
CRCL		CRC

Field Name	Example(HEX)	Description
Slave Address	0x7F	
Function	0x06	
Register Address H	0x80	
Register Address L	0x00	
Present Data1 H	0x00	
Present Data1 L	0x02	
CRCH		CRC
CRCL		CRC

4

0x10

Field Name	Example(HEX)	Description
Slave Address	0x7F	
Function	0x10	
Register Address H	0x80	
Register Address L	0x00	
Register Count H	0x00	
Register Count L	0x02	
Data Count	0x04	
Present Data1 H	0x01	1

Present Data1 L	0x2B	1
Present Data2 H	0x01	2
Present Data2 L	0x11	2
CRCH		CRC
CRCL		CRC

Field Name	Example(HEX)	Description
Slave Address	0x7F	
Function	0x10	
Register Address H	0x80	
Register Address L	0x00	
Register Count H	0x00	
Register Count L	0x02	
CRCH		CRC
CRCL		CRC

#### 4 CRC

```

u16 Modbus_CRC16(u8 *puchMsg, u16 usDataLen )
{
    u8 uchCRChi = 0xFF ; //   CRC
    u8 uchCRCLo = 0xFF ; //   CRC
    unsigned long uIndex ; // CRC

    while ( usDataLen-- ) //
    {
        uIndex = uchCRChi ^ *(puchMsg++) ; //   CRC
        uchCRChi = uchCRCLo ^ auchCRChi[uIndex] ;
        uchCRCLo = auchCRCLo[uIndex] ;
    }
}

```

```

return ( uchCRCHi << 8 | uchCRCLo );
}

/* CRC          */
const u8 auchCRCHi[] = {
    0x00, 0xC1, 0x81, 0x40, 0x01, 0xC0, 0x80, 0x41, 0x01, 0xC0,
    0x80, 0x41, 0x00, 0xC1, 0x81, 0x40, 0x01, 0xC0, 0x80, 0x41,
    0x00, 0xC1, 0x81, 0x40, 0x00, 0xC1, 0x81, 0x40, 0x01, 0xC0,
    0x80, 0x41, 0x01, 0xC0, 0x80, 0x41, 0x00, 0xC1, 0x81, 0x40,
    0x00, 0xC1, 0x81, 0x40, 0x01, 0xC0, 0x80, 0x41, 0x00, 0xC1,
    0x81, 0x40, 0x01, 0xC0, 0x80, 0x41, 0x01, 0xC0, 0x80, 0x41,
    0x00, 0xC1, 0x81, 0x40, 0x01, 0xC0, 0x80, 0x41, 0x00, 0xC1,
    0x81, 0x40, 0x00, 0xC1, 0x81, 0x40, 0x01, 0xC0, 0x80, 0x41,
    0x00, 0xC1, 0x81, 0x40, 0x01, 0xC0, 0x80, 0x41, 0x01, 0xC0,
    0x80, 0x41, 0x00, 0xC1, 0x81, 0x40, 0x01, 0xC0, 0x80, 0x41,
    0x01, 0xC0, 0x80, 0x41, 0x01, 0xC0, 0x80, 0x41, 0x00, 0xC1,
    0x81, 0x40, 0x01, 0xC0, 0x80, 0x41, 0x00, 0xC1, 0x81, 0x40,
    0x00, 0xC1, 0x81, 0x40, 0x01, 0xC0, 0x80, 0x41, 0x01, 0xC0,
    0x80, 0x41, 0x00, 0xC1, 0x81, 0x40, 0x01, 0xC0, 0x80, 0x41,
    0x00, 0xC1, 0x81, 0x40, 0x00, 0xC1, 0x81, 0x40, 0x01, 0xC0,
    0x80, 0x41, 0x00, 0xC1, 0x81, 0x40, 0x01, 0xC0, 0x80, 0x41,
    0x01, 0xC0, 0x80, 0x41, 0x00, 0xC1, 0x81, 0x40, 0x01, 0xC0,
    0x80, 0x41, 0x00, 0xC1, 0x81, 0x40, 0x00, 0xC1, 0x81, 0x40,
    0x01, 0xC0, 0x80, 0x41, 0x01, 0xC0, 0x80, 0x41, 0x00, 0xC1,

```

```

0x81, 0x40, 0x00, 0xC1, 0x81, 0x40, 0x01, 0xC0, 0x80, 0x41,
0x00, 0xC1, 0x81, 0x40, 0x01, 0xC0, 0x80, 0x41, 0x01, 0xC0,
0x80, 0x41, 0x00, 0xC1, 0x81, 0x40
};

```

38

```

/* CRC */
const u8 auchCRCLo[] = {
    0x00, 0xC0, 0xC1, 0x01, 0xC3, 0x03, 0x02, 0xC2, 0xC6, 0x06,
    0x07, 0xC7, 0x05, 0xC5, 0xC4, 0x04, 0xCC, 0x0C, 0x0D, 0xCD,
    0x0F, 0xCF, 0xCE, 0x0E, 0x0A, 0xCA, 0xCB, 0x0B, 0xC9, 0x09,
    0x08, 0xC8, 0xD8, 0x18, 0x19, 0xD9, 0x1B, 0xDB, 0xDA, 0x1A,
    0x1E, 0xDE, 0xDF, 0x1F, 0xDD, 0x1D, 0x1C, 0xDC, 0x14, 0xD4,
    0xD5, 0x15, 0xD7, 0x17, 0x16, 0xD6, 0xD2, 0x12, 0x13, 0xD3,
    0x11, 0xD1, 0xD0, 0x10, 0xF0, 0x30, 0x31, 0xF1, 0x33, 0xF3,
    0xF2, 0x32, 0x36, 0xF6, 0xF7, 0x37, 0xF5, 0x35, 0x34, 0xF4,
    0x3C, 0xFC, 0xFD, 0x3D, 0xFF, 0x3F, 0x3E, 0xFE, 0xFA, 0x3A,
    0x3B, 0xFB, 0x39, 0xF9, 0xF8, 0x38, 0x28, 0xE8, 0xE9, 0x29,
    0xEB, 0x2B, 0x2A, 0xEA, 0xEE, 0x2E, 0x2F, 0xEF, 0x2D, 0xED,
    0xEC, 0x2C, 0xE4, 0x24, 0x25, 0xE5, 0x27, 0xE7, 0xE6, 0x26,
    0x22, 0xE2, 0xE3, 0x23, 0xE1, 0x21, 0x20, 0xE0, 0xA0, 0x60,
    0x61, 0xA1, 0x63, 0xA3, 0xA2, 0x62, 0x66, 0xA6, 0xA7, 0x67,
    0xA5, 0x65, 0x64, 0xA4, 0x6C, 0xAC, 0xAD, 0x6D, 0xAF, 0x6F,
    0x6E, 0xAE, 0xAA, 0x6A, 0x6B, 0xAB, 0x69, 0xA9, 0xA8, 0x68,
    0x78, 0xB8, 0xB9, 0x79, 0xBB, 0x7B, 0x7A, 0xBA, 0xBE, 0x7E,
    0x7F, 0xBF, 0x7D, 0xBD, 0xBC, 0x7C, 0xB4, 0x74, 0x75, 0xB5,

```

0x77, 0xB7, 0xB6, 0x76, 0x72, 0xB2, 0xB3, 0x73, 0xB1, 0x71,  
 0x70, 0xB0, 0x50, 0x90, 0x91, 0x51, 0x93, 0x53, 0x52, 0x92,  
 0x96, 0x56, 0x57, 0x97, 0x55, 0x95, 0x94, 0x54, 0x9C, 0x5C,  
 0x5D, 0x9D, 0x5F, 0x9F, 0x9E, 0x5E, 0x5A, 0x9A, 0x9B, 0x5B,  
 0x99, 0x59, 0x58, 0x98, 0x88, 0x48, 0x49, 0x89, 0x4B, 0x8B,  
 0x8A, 0x4A, 0x4E, 0x8E, 0x8F, 0x4F, 0x8D, 0x4D, 0x4C, 0x8C,  
 0x44, 0x84, 0x85, 0x45, 0x87, 0x47, 0x46, 0x86, 0x82, 0x42,  
 0x43, 0x83, 0x41, 0x81, 0x80, 0x40

};

## 5 MFPT-M+ MODBUS

		short	W/ R		
	25	1	R	PD bit4 bit[3:0]	7F03001900015FD3 7F03027800B24E
	30000	1	R		7F03753000019417 7F0302000A1049 10ns
	30001	1	R	0-255 255 100% 0 0%	7F0375310001C5D7 7F03020000904E 0

	30002	2	R	1-4000kHz =100000/	7F037532000275D6 7F0304271000006F45 0x00002710 10000 10kHz
GUI/ DB25	30025	1	W/R	Bit0 / (1 GUI 0 DB25 ) Bit1 (1 GUI 0 DB25 ) Bit2 (1 GUI 0 DB25 ) Bit3 (1 GUI 0 DB25 )	7F037549000145CE 7F03020000904E DB25 GUI 7F067549000F080A 7F067549000F080A GUI
	30026	1	W	0-255 255 100% 0 0%	20% 7F06754A0033F81B 0033 7F06754A0033F81B
	30027	2	W	1-4000kHz =100000/ MO BS	100kHz 7F10754B000204 03E80000F2E7 03E80000 03E8 0000 7510754B00022166

	30029	1	W	MO BS	100ns 7F06754D00640824 0064 7F06754D00640824
MO	30030	1	W/R	OFF 0x0000 ON 0x0001	7F06754E0001380F 7F06754E0001380F MO
BS	30031	1	W/R	OFF 0x0000 ON 0x0001	7F06754F000169CF 7F06754F000169CF BS
PD	30032	1	W/R	OFF 0x0000 ON 0x0001	7F06755000015809 7F06755000015809 PD
	30033	1	W/R	OFF 0x0000 ON 0x0001	7F067551000109C9 7F067551000109C9
	40004	1	R		7F039C440001E051 7F0302001D5047 0x001D 29

## 第六章 常见故障处理

### 1 -

1

2

3

4

5 DB25

6 PIN18 PIN19

7

5.2 DB25

### 2 -

1

2

3

4

5

2

6

7

## 第七章 服务与维修

1 -

2 -

400-900-9588

## 第八章 保修声明

1 -

2 -

1  
2  
3  
4  
5  
6