

MAX 创鑫激光



MFSC 1500X(G6.1)

使用手册

版权说明

“ ”

引 语

MFSC

MFSC

公司简介

2004

<http://www.maxphotonics.com>



深圳市创鑫激光股份有限公司

:
: <http://www.maxphotonics.com>
: 400-900-9588
: +86-755-36869371
: info@maxphotonics.com

.....	1
MFSC	4
	5
1-	5
2-	6
3-	6
4-	7
5-	11
	12
1-	12
2-	12
3-	12
4-	13
5-	13
6-	14
7-	14
	15
1-	15
2-	16
3-	16
4-QBH	17
5-	18

6-	19
		21
1-	21
2-	22
		23
1-	23
2-	23
3-	23
4-	27
5-	27
6-	28
7-	32
		33
1-	33
2-	33
		37
1-	37
2-	37
		38
1-	38
2-	38

第一章 MFSC 系列激光器 特性说明

MFSC

1060nm-1100nm





>30%

MFSC

Class 4

第二章 安全信息

1 -

安全标识	描述
	 
	
	

MFSC

1060nm~1100 nm

2-

1. 激光防护要求

2. 激光防护设备商

LaserVision USA Kentek Corporation Rochwell Laser Industries

3-

电磁兼容与抗干扰性:

EN IEC 61000-6-4:2019

CISPR 16-2-1

CISPR 16-2-3

EN IEC 61000-6-2:2019

EN 61000-4-2:2009

EN 61000-4-3:2020

EN 61000-4-4:2012

EN 61000-4-5:2014+A1:2017 EN 61000-4-6:2014

EN 61000-4-11:2020

EN 60825-1:2014+A11:2021

CDRH 21 CFR 1040.10

EN 60204-1:2018

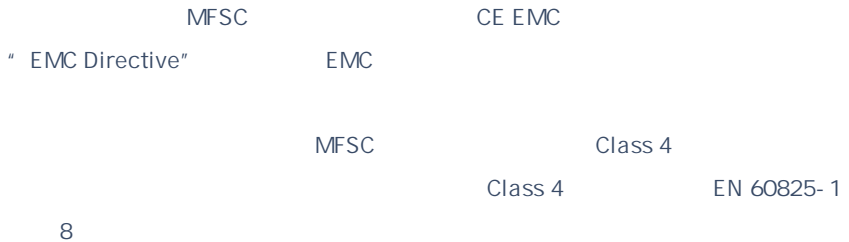

4 -

1. 镜面反射

2. 配件安全须知

MFSC

3. 光学操作须知

创鑫激光强烈建议您阅读下述操作要点后再行操作激光器：

1

2

3

4

5

6

7

8

9

10

11

12

" "

4. 电气操作须知

创鑫强烈建议您阅读下述操作要点后再行操作激光器：

1

2

3

4

32A

5

200-

240VAC

6

7

200-240VAC

5. 激光器操作环境要求

创鑫推荐您按照如下的措施操作，以期延长激光器的使用寿命：

1

2

3

0

5-

如果您需要获取更多的激光器安全方面的信息，请参考如下：

Laser Institute of America(LIA)

13501 Ingenuity Drive, Suite 128

Orlando,Florida 32826

Phone:407 380 1553,Fax: 407 380 5588

Toll Free:1 800 34 LASER

American National Standards Institute

ANSI Z136.1, American National Standard for the Safe Use of Lasers

(Available through LIA)

International Electro-technical Commission

IEC 60825-1, Edition 1.2

Center for Devices and Radiological Health

21 CFR 1040.10 - Performance Standards for Light-Emitting Products US

Department of Labor - OSHA

Publication 8-1.7 - Guidelines for Laser Safety and Hazard Assessment.

Laser Safety Equipment

Laurin Publishing

Laser safety equipment and Buyer's Guides

第三章 产品描述

1-

MFSC

主要特性有：

- 1
- 2
- 3
- 4
- 5

应用领域：

- 1
- 2

2-

6

6.3-6.6

3-

M - F - S - C - X X X - X X
1 - 2 - 3 - 4 - 5 - 6

1		M	Maxphotronics
2		F	Fiber Laser
3		S	Single Mode

4		C	ContinueWave
5	XXXX		XXXX W
6			

4-

5-



名称	功能说明
ALARM	
ACTIVE	
POWER	
(OFF/ON)	
(EMERGENCY STOP)	
START	

6-



名称	功能说明
AC220V	200-240VAC
POWER	200-240VAC
ETHERNET	
CTRL	
BLUETOOTH	
WATER IN	12)
WATER OUT	12)
OPTICAL OUTPUT	
	

7-

1. 光纤输出头

6.4

QBH

G4.2 QBH

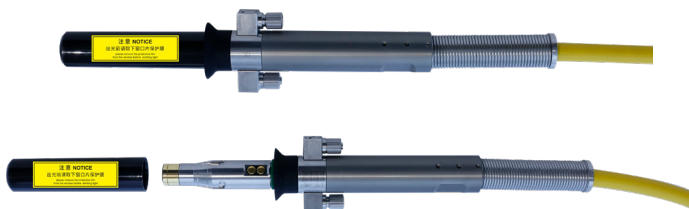

第四章 详细规格

1-

序号	特性参数	测试条件	最小值	典型值	最大值	单位
1			/			
2						
3	MFSC-1500X(G6.1)	100%		1500		W
4			10		100	%
5		100%	1070	1080	1090	nm
6	3dB	100%		4	6	nm
7		100% >1h		± 1	± 1.5	%
8		100% >24h		± 2	± 3	%
9	BPP MFSC-1500X(G6.1)	50um-QBH			1.5	mm x mrad
10		10% 90%		50	100	μs
11		90% 10%		50	100	μs
12		100%			20	KHz
13		100%	200			μW
14	MFSC-1500X(G6.1)		15 (5 10)			m
15	MFSC-1500X(G6.1)		50			μm
16			200			mm
17		QBH LOC				

2-

序号	特性参数	测试条件	最小值	典型值	最大值	单位
1			200	220	240	VAC
2		100%			4.5	KW
3			10		40	
4			10		85	%
5						
6			-10		60	
7		382 W × 410 D × 115 H				mm
8		22± 2				kg

3-

序号	特性	参数	单位
1			
2		24	20
		18	
3		4	bar
4	MFSC-1500X(G6.1)	12-16	L/min
5	MFSC-1500X(G6.1)	3.5	kw

40

24± 2 (18)

;

p 0.5bar

;

0

20% ()

-15C

4-QBH 水冷条件

冷却方式	水管尺寸要求	水流量 (L/min)	水压 (bar)	冷却水温 (°C)
	* = 6* 4	2	3	28-30

8mm 20m ;
 QBH 6 1m ;
 QBH ;
 p 1.5bar

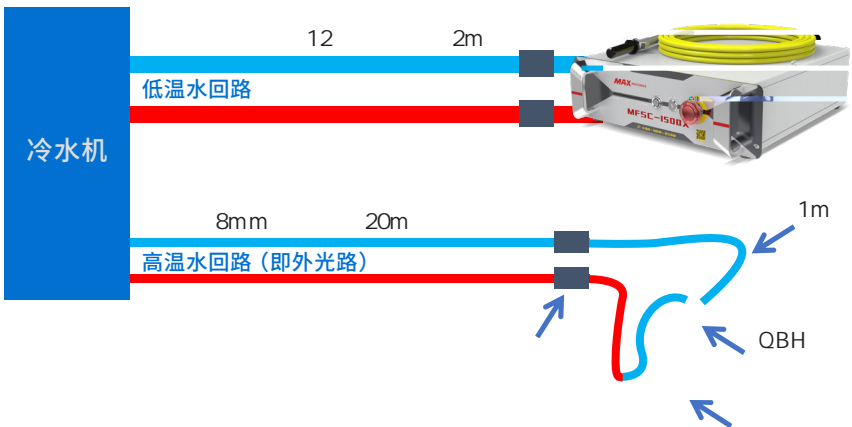

5- 安装环境需求

- 1 1000
- 2 10 - 40
- 3 10% - 85%
- 4 :

%	Td ()													
	30	35	40	45	50	55	60	65	70	75	80	85	90	95
10	-7.0	-5.0	-3.0	-1.3	0.0	1.5	2.5	3.6	4.8	5.8	6.7	7.6	8.4	9.2
11	-6.5	-4.0	-2.0	-0.5	1.0	2.5	3.5	4.8	5.8	6.7	7.7	8.6	9.4	10.2
12	-5.0	-3.0	-1.0	0.5	2.0	3.3	4.4	5.5	6.7	7.7	8.7	9.5	10.9	11.2
13	-4.5	-2.0	-0.2	1.4	2.8	4.1	5.3	6.6	7.7	8.7	9.6	10.5	11.4	12.2
14	-3.2	-1.0	0.7	2.2	3.5	5.1	6.4	7.5	8.6	9.6	10.6	11.5	12.4	13.2
15	-2.3	-0.3	1.5	3.1	4.6	6.0	7.3	8.4	9.6	10.6	11.6	12.5	13.4	14.2
16	-1.3	0.5	2.4	4.0	5.6	7.0	8.3	9.5	10.6	11.6	12.6	13.4	14.3	15.2
17	-0.5	1.5	3.2	5.0	6.5	8.0	9.2	10.2	11.5	12.5	13.5	14.5	15.3	16.2
18	0.2	2.3	4.0	5.8	7.4	9.0	10.2	11.3	12.5	13.5	14.5	15.4	16.4	17.2
19	1.0	3.2	5.0	7.2	8.4	9.8	11.0	12.2	13.4	14.5	15.4	16.5	17.3	18.2
20	2.0	4.0	6.0	7.8	9.4	10.7	12.0	13.2	14.4	15.4	16.5	17.4	18.3	19.2
21	2.8	5.0	7.0	8.6	10.2	11.0	12.9	14.2	15.3	16.4	17.4	18.4	19.3	20.2
22	3.5	5.8	7.8	9.5	11.0	12.5	13.8	15.2	16.3	17.3	18.4	19.4	20.3	21.2
23	4.4	6.8	8.7	10.4	12.0	13.5	14.8	16.2	17.3	18.4	19.4	20.4	21.3	22.2
24	5.3	7.7	9.7	11.4	13.0	14.5	15.8	17.0	18.2	19.3	20.4	21.4	22.3	23.1
25	6.2	8.6	10.5	12.3	14.0	15.4	16.8	18.0	19.1	20.3	21.3	22.3	23.2	23.9
26	7.0	9.4	11.4	13.2	14.8	16.3	17.7	19.0	20.1	21.2	22.3	23.3	24.2	25.1
27	8.0	10.3	12.2	14.0	15.8	17.3	18.7	19.9	21.1	22.2	23.2	24.3	25.2	26.1
28	8.8	11.2	13.2	15.0	16.7	18.0	19.6	20.9	22.0	23.0	24.2	25.2	26.2	27.1
29	9.7	12.0	14.0	15.9	17.6	19.2	20.5	21.3	23.0	24.1	25.2	26.2	27.2	28.1
30	10.5	12.9	14.9	16.8	18.5	20.0	21.4	22.8	23.9	25.1	26.2	27.2	28.2	29.1
31	11.4	13.8	15.9	17.8	19.4	20.9	22.4	23.0	24.8	26.0	26.9	28.2	29.2	30.1
32	12.2	14.7	16.8	18.6	20.3	21.9	23.3	24.6	25.8	27.0	28.1	29.2	30.1	31.1
33	13.0	15.6	17.6	19.6	21.3	22.9	24.2	25.6	26.8	28.0	29.0	30.1	32.1	32.1
34	13.9	16.5	18.6	20.5	22.2	23.8	25.2	26.5	27.7	29.0	29.5	31.1	32.1	33.1
35	14.9	17.4	19.5	21.4	23.0	24.6	26.2	27.5	28.7	29.9	31.0	32.1	33.1	34.1
36	15.7	18.1	20.3	22.2	24.0	25.0	27.0	28.4	29.0	30.9	32.0	33.1	34.1	35.2
37	16.6	19.2	21.2	23.2	24.9	26.5	27.9	29.5	30.7	31.8	33.0	34.1	35.2	36.2
38	17.5	19.9	22.0	23.9	25.8	27.4	28.9	30.3	31.5	32.0	33.9	35.1	36.0	37.0
39	18.1	20.8	23.0	24.9	26.6	28.3	29.8	31.2	32.5	33.8	34.9	36.2	36.8	38.1
40	19.2	21.6	23.8	25.8	27.6	29.2	30.7	32.1	33.5	34.7	35.8	36.8	38.1	39.1

6

mm

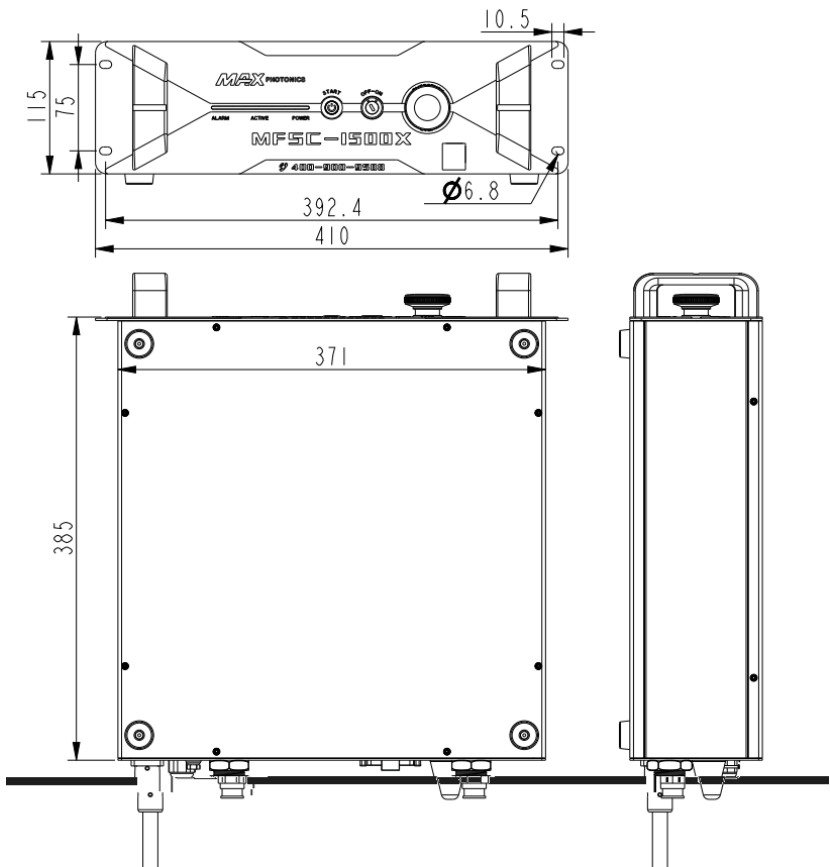

mm

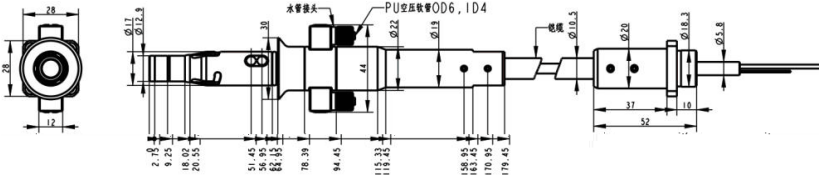

1-

激光器属于精密贵重物品，创鑫推荐您按如下步骤拆装包装箱。

1

2

3 " "

4 QBH

>200mm

2-

序号	名称	规格型号	单位	数量
1		MFSC-1500X(G6.1)		1
2	()	/		1
3		/		1
4		/		2
5	QBH	6x4mm		1
6		12*8mm		1
7		/		1
8		/		1
9	(2*2)	/		6
10		/		1
11		12*28.5mm		6

第六章 使用指南

1-

4

2

2-

32A

4

3-

G6.1-1500X

CTRL

DB44

1500X(G6.1) CTRL

CTRL 接口 插孔序号	接线 颜色	英文标签	中文标签	说明
34		EXLOCK_CH1A	1A	AB
33		EXLOCK_CH1B	1B	
38		EMERGENCY1_ INPUT 1A	1A	
37		EMERGENCY1_ INPUT 1B	1B	
19		ENABLE1+	1+	I 20VDC V 30VDC OVDC V 5VDC 5mA
4		ENABLE1-	1-	
17		PWM1+	1+	I 20VDC V 30VDC OVDC V 5VDC 5mA
2		PWM1-	1-	
14		AN1_PWR_ PEAK_10V+	0-10V +	1V-10% 10V-100% I 1mA
29		AN1_PWR_ PEAK_10V-	0-10V -	
40		ERROR/ALARM_A	A	- V 30VDC, I 100mA
39		ERROR/ALARM_B	B	
13	NC			
23		CONTROL A	A	AB AB
8		CONTROL B	B	
			PE	

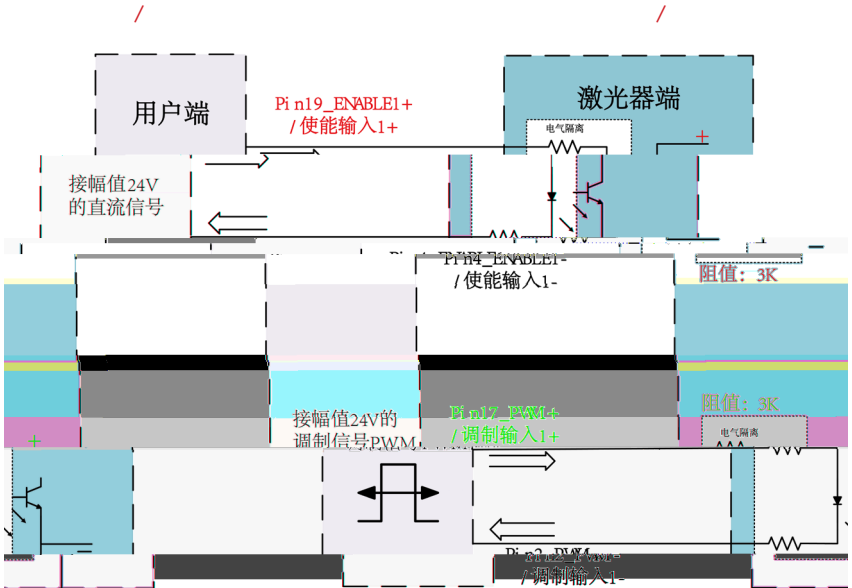
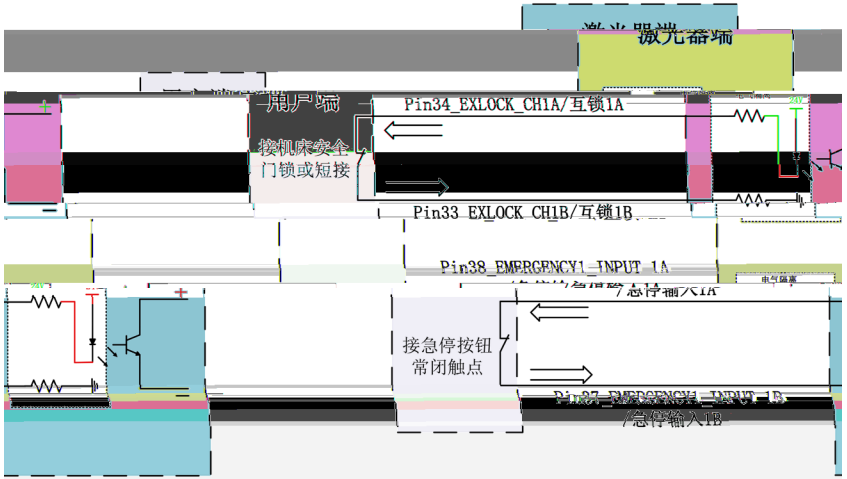

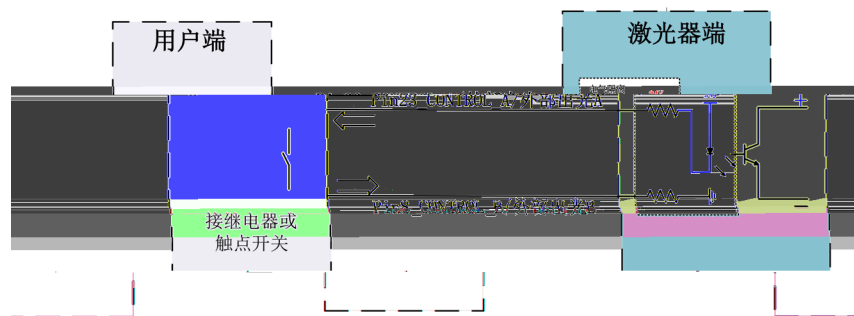
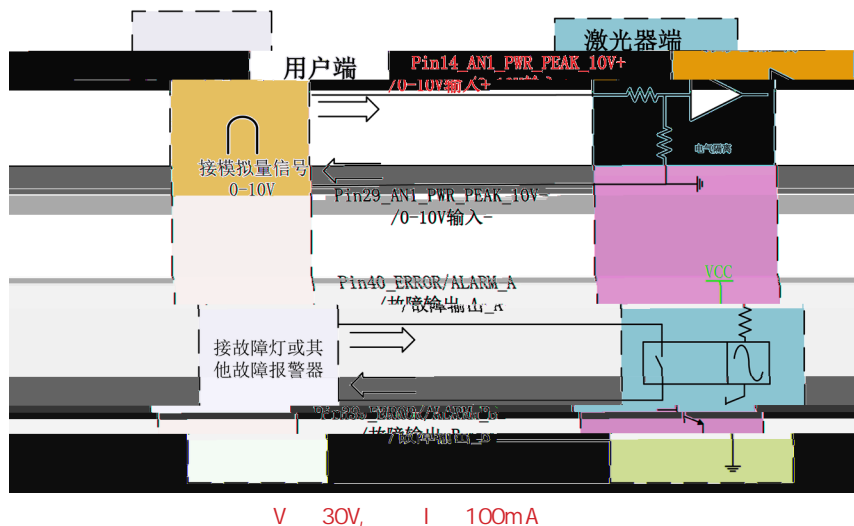

:

()

/ ;

4-

启动流程如下所示：

- 1
- 2
- 3
- 4
- 5

5-

激光器工作模式如下：

- 1
- 2
- 3

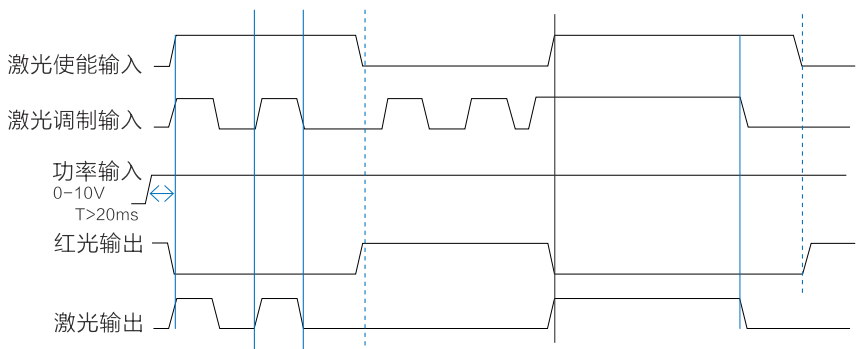

6-

1 " " " " " " NET4.6" G6-Series-n.
n.n.n"

<http://www.maxphotonics.com/Cn/Software.html>

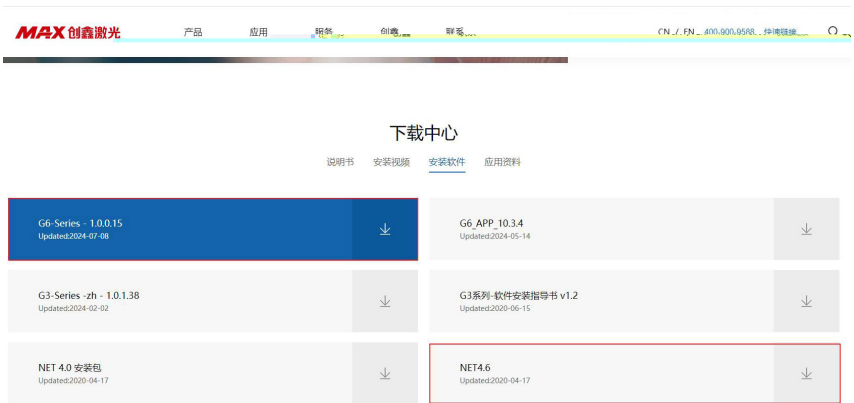

2 NET4.6 Win10 .NET 4.6
NET4.6

3 G6-Series-n.n.n.n " G6-Series"



4 EtherNet

5 " G6-Series"

IP 192.168.0.178 " "



6



7



8



9

NO.	本地日期	本地时间	用户	类型	项名	值
1.	2024/06/28	10:25:03	lee (工程权限)	状态反馈	通讯	Lock
2	2024/06/28	10:25:03	lee (工程权限)	状态反馈	Ready	OFF
3	2024/06/28	10:25:03	lee (工程权限)	状态反馈	激光	OFF
4	2024/06/28	10:25:03	lee (工程权限)	状态反馈	主电源	OFF
5	2024/06/28	10:25:03	lee (工程权限)	状态反馈	Start	OFF
6	2024/06/28	10:25:03	lee (工程权限)	致命报警	急停1	
7	2024/06/28	10:25:03	lee (工程权限)	致命报警	面板急停	
8	2024/06/28	10:25:03	lee (工程权限)	致命报警	激光器主机电源切换故障	
9	2024/06/28	10:25:03	lee (工程权限)	致命报警	电源致命报警	
10	2024/06/28	10:25:03	lee (工程权限)	致命报警	机器异常报警	
11	2024/06/28	10:25:03	lee (工程权限)	非致命报警	TF	
12	2024/06/28	10:25:03	lee (工程权限)	状态反馈	内吸功能	OFF
13	2024/06/28	10:25:03	lee (工程权限)	致命报警	PS-1: 通讯	
14	2024/06/28	10:25:03	lee (工程权限)	致命报警	PS-1: AC输入	
15	2024/06/28	10:25:03	lee (工程权限)	致命报警	PS-1: 温度输入	

MAX 创鑫激光

软件版本: 1.0.0.15 (2024/05/13)

7-

序号	故障名称	故障原因	备注
1			
2			
3			
4			
5	QBH	QBH	QBH QBH QBH
6			ALARM ACTIVE

第七章 光纤连接器检查和清洁指南

1-

清洁光纤连接器，您需要如下器材：

- 1
- 2
- 3
- 4
- 5
- 6
- 7

2-

1

2

3

7-1

4

7-2

5

6

QBH

7

7-3

14

8



7-1

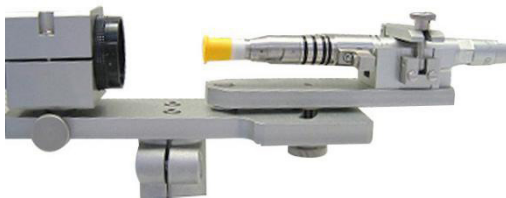

7-1



7-3

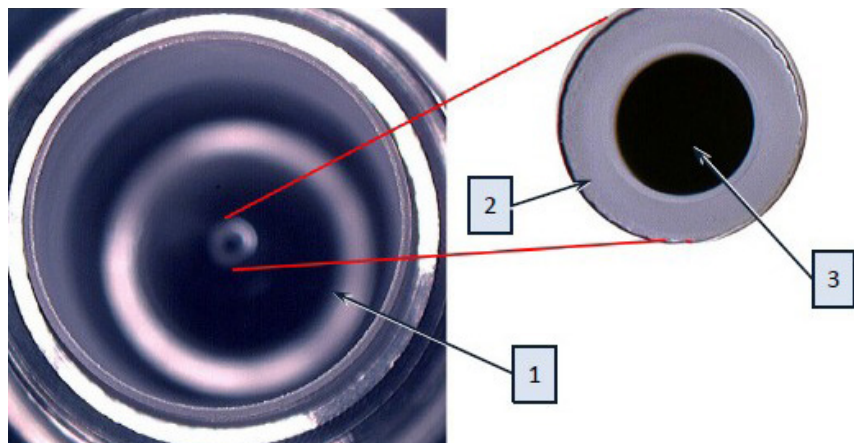

1

2

3

7-4

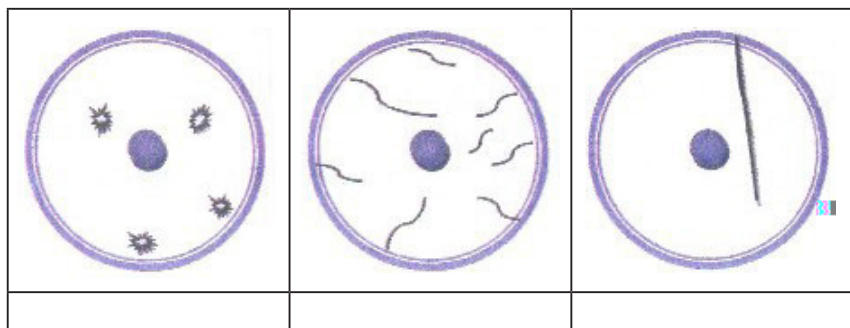

7-5

第八章 服务与维修

1-

2-

400-900-9588

第九章 保修声明

1-

2-

1
2
3
4
5
6